



ITTEST

QUESTION & ANSWER

Guías de estudio precisos, Alta tasa de paso!



Ittest ofrece información actualizada de forma gratuita en un año!

<http://www.ittest.es/>

Exam : **0B0-105**

Title : BEA8.1 Certified
Architect:Enterprise
Architecture

Version : DEMO

1. Smithers and Dithers must now support interaction with business applications that use ebXML and RosettaNet B2B protocols. Which architectural approach would best satisfy this new requirement?

Smithers and Dithers Background

History and project background

Smithers and Dithers (S&D) is a well-established, well-respected retail apparel company that has been in business for forty years; it currently implements thirty custom product lines in five separate retail divisions; each division comprises many retail locations across the United States. Although the day-to-day store operations are handled locally for each chain and managed through local POS systems, S&D's corporate headquarters handles all back-office business operations for each retail division as a whole. As a result of its longevity, the size and complexity of its operations, and a series of acquisitions, S&D currently supports many large-scale and legacy applications.

The primary legacy applications are as follows:

- **PeopleSoft-based Human Resources (HR) system:** all employee information, including corporate information, employee benefits package, timesheets, and so on, for every Smithers and Dithers employee, is stored in the corporate PeopleSoft implementation. Employee new-hire and status-change information is also stored in the corporate PeopleSoft system.
- **Customer Relationship Management (CRM) system:** S&D uses a CRM system provided by NCR; this choice allowed Smithers and Dithers to leverage their existing Teradata Data Warehouse, and incorporate capabilities to target the right kind of merchandise at the right type of customer, based on demographic and geographic information. This system is successfully used by Marketing to analyze and predict customer trends and help in creating special promotions and ad campaigns.
- **Custom accounting system:** S&D uses a proprietary accounting system that has been in use by their chains for many years. The system was written in Cobol; it uses CICS for transaction monitoring and management. Correct integration with the accounting system is crucial to the POS project, because the other systems rely on this system.
- **Inventory control system:** the inventory system employed by S&D is a custom application. It has been evolving for many years. It is complex, and it integrates with the existing accounting system, SCM system, and warehouse. Interestingly, in addition to regular inventory control functions, the inventory system contains the purchase ordering functionality for all of the retail divisions.
- **Supply Chain Management:** this is another custom application, running on the S&D mainframe, leveraging a DB2-based data store. The current system is very sophisticated; it is designed around the following key ideas:

- Fulfillment optimization
- Logistics optimization
- Production optimization
- Revenue and profit optimization

S&D also has a fairly complex reverse supply chain process in place, that allows for reselling certain merchandise back to its suppliers. S&D also participates in buying, from other chains, discounted merchandise that matches its current inventory offerings.

As you might imagine, S&D has some very complex business processes in place. S&D was not immune to the process re-engineering craze of the 1990's, and, for the most part, the company has been the better for it.

Although its processes are highly refined and streamlined, the CIO, CEO and Board of Directors feel that the business itself is in need of some restructuring of electronic resources and business processes to provide more agility and competitiveness moving forward. The CIO and IT division heads have been researching ways to provide this agility and resiliency across S&D operations; they finally decided to standardize on Java and J2EE, as language and platform, respectively.

This decision was helped by the fact S&D successfully implemented a few J2EE-based applications that support electronic commerce (e-commerce); the most notable is a portal application that provides an online catalog and e-tailing capabilities for each retail division.

S&D's standardized application server and portal choices for this project are WebLogic Application Server and WebLogic Portal. The company has made significant economic and resource investments in the BEA line of enterprise platform products.

The architecture oversight committee decided to break the re-architecture of S&D operations into two main stages.

Stage 1 includes redesigning, implementing, deploying and testing **storefront operations**. Storefront operations are defined as the key day-to-day retail operations conducted through each S&D chain, which will be handled through a newly-defined Point of Sale (POS) system.

Storefront operations include:

- Store inventory management
- Store operations: hiring, firing, training and general management of employees
- Processing sales transactions
- Processing deliveries

Many POS systems do not provide all this functionality directly; S&D's current system does not. This has been a source of frustration to department and general managers for several years, and they identify this problem as one key reason for S&D's declining competitiveness in the retail space. As a result, S&D sees a great opportunity to incorporate new functionality into the system.

Stage 2, to be completed after Stage 1 is successfully executed, includes redesigning, implementing, integrating, deploying and testing **corporate, or back-office, operations**. Corporate operations are defined as all the business processes and enterprise information systems in use by S&D.

Corporate operations include:

- Buying merchandise and coordinating a vast network of suppliers
- Coordinating inventory and logistics for each S&D outlet
- Human Resource management (payroll, and so on)
- Marketing, marketing analyses and advertising
- Daily warehouse operations

Although this is not a complete list of storefront and corporate operations, these examples indicate the complexities involved.

Scope

You have been hired as the new Enterprise Architect for the Smithers and Dithers Corporation. You will assume this role for the entire assessment, and your primary responsibility is for the design and definition of Stage 1 of S&D's vision.

You will demonstrate a thorough understanding and knowledge of enterprise architecture through the key decisions that you will be required to make and support, through complex scenarios and general knowledge-based questions.

The assessment uses the Unified Modeling Language (UML) throughout, but it does not impose any particular methodology or taxonomy on you. You will be armed with S&D's vision statement, current analyses documentation, and a record of key business processes that must be implemented in Stage 1, and with WebLogic and industry-accepted best practices for architecture, security and design.

The primary analysis tools that you will have to work with are as follows.

Use Case Model	The key POS system; internal and external actors
Activity Diagrams	Visual representation of Use Cases and key business processes that must be implemented in the POS system
Use Cases	Baseline requirements for the POS system
Network Model	Analyses of S&D's current network architecture
Data Model	Representation of entities and relationships to be used by the POS system; and formatting constraints
Security Model	Proposed security requirements and baseline analyses of S&D's current security architecture
Non-functional requirements	Important requirements that cannot be directly attributed to a specific Use Case

Every key piece of information that you need is provided in the documentation, as either a key artifact or an appendix. You are expected to focus only on the implementation of the requirements and analyses for Stage 1 of S&D's application rollout.

Good luck!

Smithers and Dithers Artifacts

The following artifacts represent sample Use Case diagrams, Activity diagrams, Network Model, Data Model and non Functional Requirements. Each of these is a small sampling of the overall Smithers and Dithers architecture needed to successfully answer several of the certification questions. None of them are meant to represent the complete or thorough architecture design.

1.0 Non-Functional Requirements

Rapid application development	
	Construction will follow a RAD framework and ideology as much as
1.1	feasible to reduce the overall completion and implementation time
	Construction will utilize industry standardized and accepted application
1.2	frameworks as much as possible
	Construction will utilize only tested and proven elements of the J2EE
1.3	specification
Enterprise Wide Security	
	Confidentiality and integrity of data transmissions must be guaranteed for
1.1	critical system and sensitive batch processing
	Transport layer as well as message layer security must be available for all
1.2	sensitive operations
	Enterprise wide auditing and non-repudiation must be available for all
1.3	business operations
	Security framework must use open standards and Public Key
1.4	Infrastructure
	Enterprise auditing must be available for all key business operations
1.5	Enterprise auditing must be available for all key business operations
	Confidentiality and integrity of employee personal data must be
1.6	guaranteed
	Transport layer as well as message layer security must be available for all
1.7	sensitive financial transactions

Enterprise wide auditing and non-repudiation must be available for all
1.8 financial transactions
1.9 Enterprise auditing must be available for all key business operations
Employees must have the ability to manage their own accounts and
1.10 passwords
1.11 Authenticated user access must be provided by single sign on
Performance and Scalability
1.1 Sub-second response time 80% of the time for all financial updates
1.2 Support for large scale batch processing
1.3 Support for one thousand concurrent users, plan for ten thousand
1.4 Utilize a multi-tiered multi-architected cluster
All data transactions must complete within 35 seconds there should be
1.5 minimal resource timeouts or rollbacks
Availability
The terminal application must be available during normal store business
hours with an error of margin no greater than .02 percent, after hours no
1.1 greater than .05 percent
The employee maintenance application must be available during normal
1.2 corporate business hours with a margin of error no greater than 2 percent
Crucial financial systems involved in inventory, general ledger and
external trading must be available 24 hours a day six days a week with a
1.3 margin of error no greater than .004 percent

Table 1.1 Non Functional Requirements

2.0 Use Case Diagrams

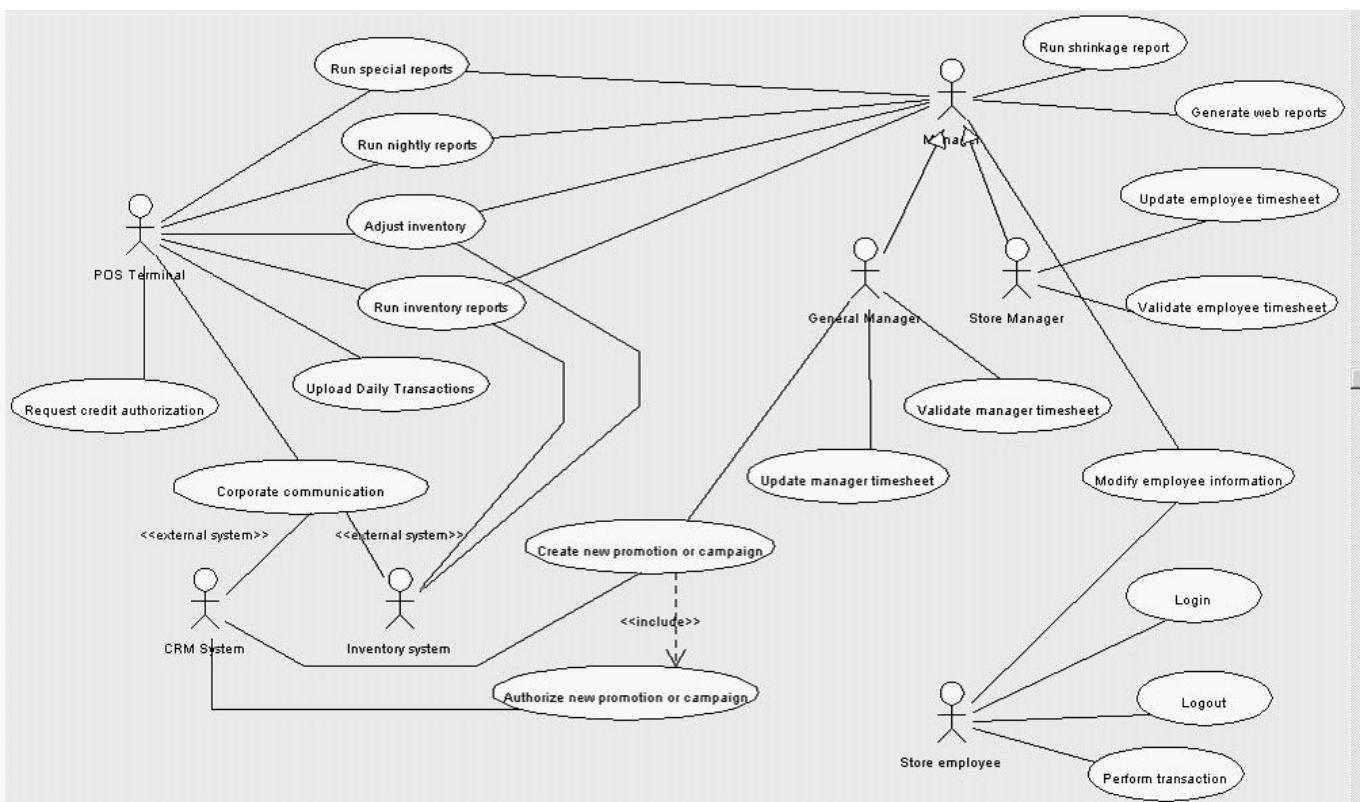

Use Case Diagram 2.0.1 Store POS Application

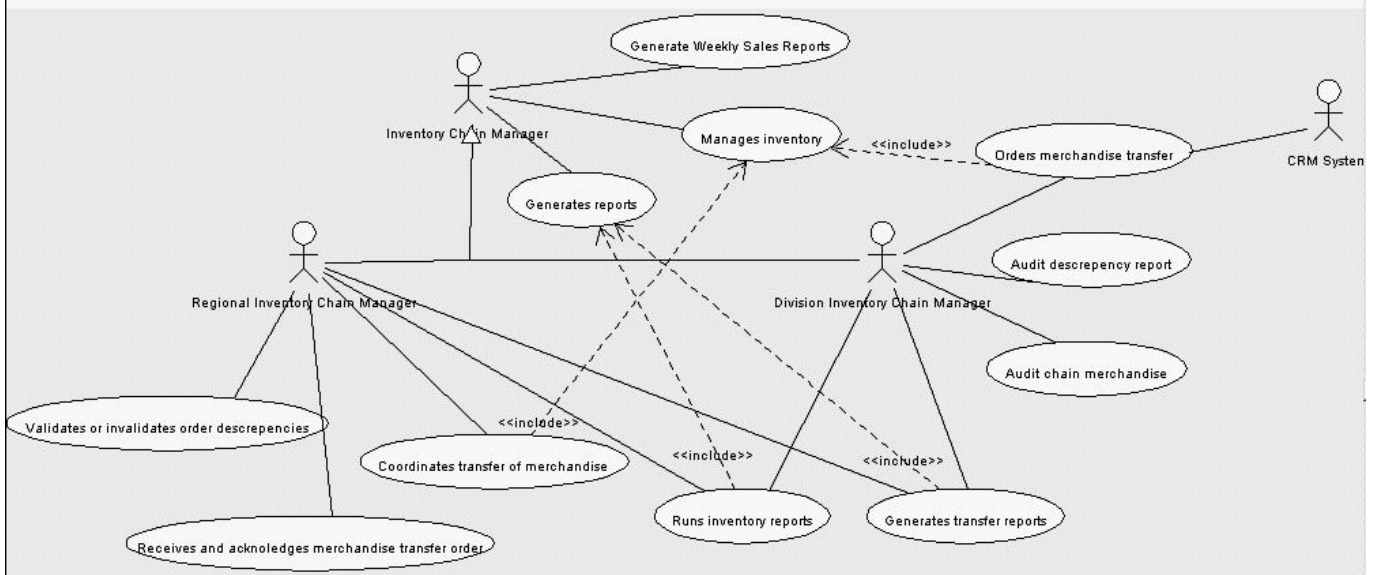

3.0 Sample Requirements and Activity Diagrams

Each Use Case below is really a snippet from the Use Case that defines the basic functional requirements from a very high level. For each sample Use Case statement, there is a Use Case diagram and an activity diagram that explain the path through the Use Case.

Use Case FR001 Run nightly reports functional requirements:

Nightly reports are summaries of all the transactions and status for the previous selling day. The nightly reporting system shall provide a summary of all the daily transaction information that will be the same detail that was stored in the DAILY_TRANSACTIONS data table. Nightly reports shall provide a summary of all merchandise sold by department and merchandise code, merchandise sales by price, and transactions of multiple groupings.

Figure 3.0.1 shows the activity diagram for this process.

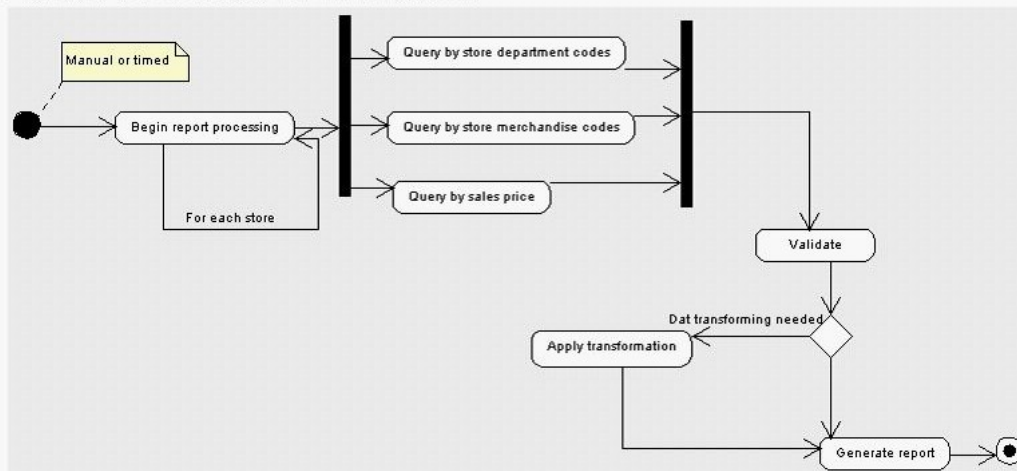

Figure 3.0.1 Run Nightly Reports

Use Case FR002 Adjust Inventory Functional Requirements:

From time to time, it is necessary to adjust the merchandise levels of S&D stores. The reasons for this include: transferring of sale and special merchandise to other retail outlets during a marketing promotion, a legitimate inventory discrepancy filed by a store manager, and discontinuation of select merchandise.

Regardless the reason for the update, the system must be capable of responding to and handling orders for adjusting the store inventory level. The POS system shall provide the ability to notify an individual outlet of an adjustment of its inventory.

The system shall provide the functionality to respond to messages and invocations from the inventory management system, notifying an outlet of an adjustment to its stock levels. The system must provide a programmatic interface and a graphical interface, for use by human and electronic processes. The system must provide a mechanism to generate a unique, verifiable adjustment notification ID, that will be used to authenticate the adjustment request.

The system shall ensure confidentiality, integrity and non-repudiation of all parties during an adjustment transaction. The POS system shall provide interfacing to, and integration with, the legacy inventory management system, and it shall accommodate future integration with disparate enterprise applications and enterprise information systems.

Figure 3.0.2 provides the activity diagram for this process.

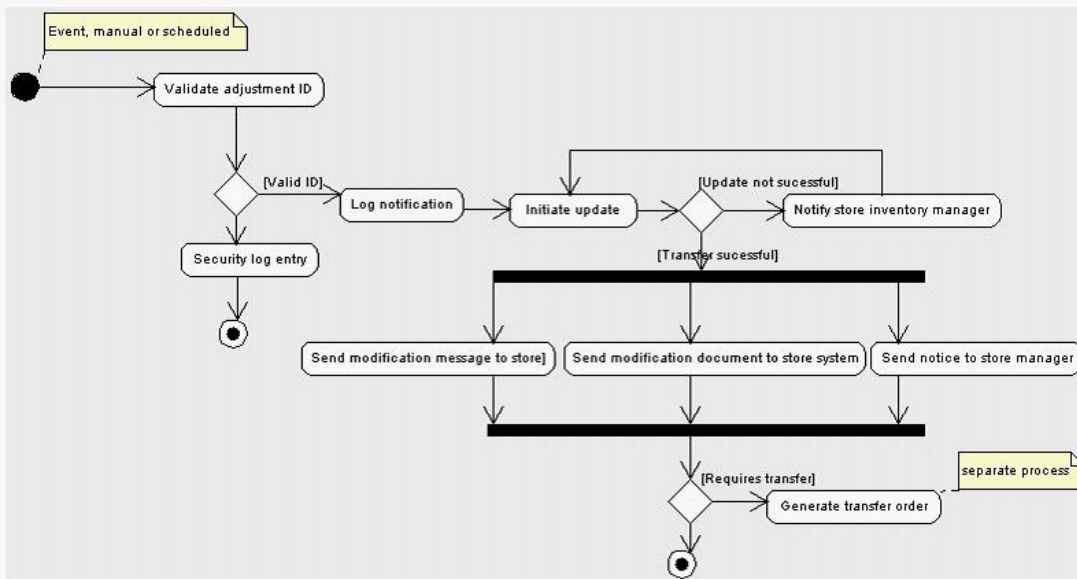

Figure 3.0.2 Adjust Inventory

Use Case FR003 Order Merchandise

A general merchandiser is assigned to each store. The merchandiser coordinates with several different brand buyers in ordering appropriate merchandise, specific to a S&D chain image.

Currently the merchandisers send PO requests to various suppliers as a manual process, defined in Figure 3.0.3 in the current as-is model. The POS system must provide functionality to allow a merchandiser to send a PO to multiple suppliers electronically. This exchange must leverage the existing infrastructure of the trading partners, and the document exchange must use well-defined, industry-standard partner interface processes. This functionality must maintain the integrity and confidentiality of documents exchanged with business partners, and it must provide authentication and authorization of external users.

Figure 3.0.3 provides the activity diagram for this process.

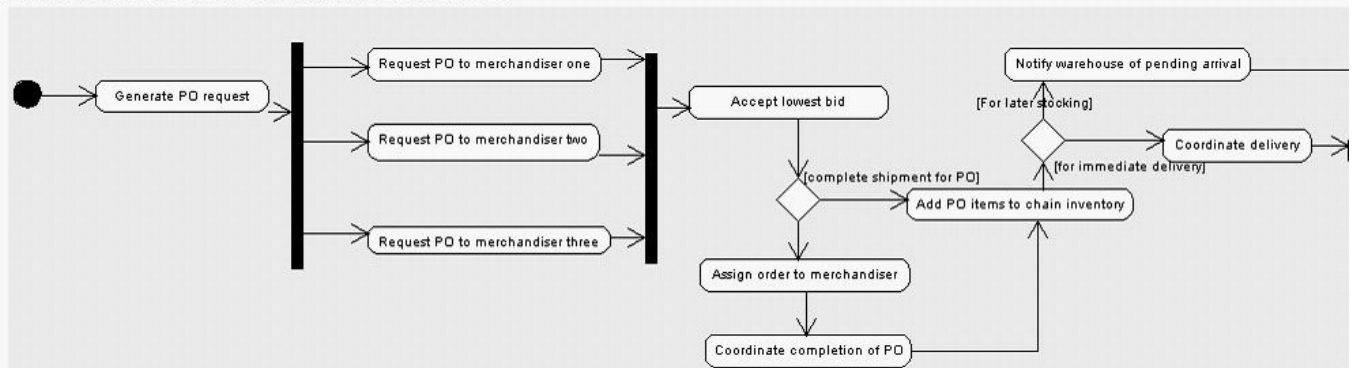

Figure 3.0.3 Order Merchandise

Use Case FR004 Daily Transaction Upload

At the end of each business day, each POS terminal of each S&D chain must upload a record of its daily transactions. Currently, the POS terminals for each store use SNA to send this data to the various mainframe systems handling general ledgers, merchandise, inventory levels, and so on.

The new system shall provide the ability for the new J2EE-based POS terminal application to continue to upload this information on a nightly basis. The terminal application shall be capable of receiving multiple data streams, in an asynchronous; loosely coupled way, and each update shall arrive to the terminal application in the form of an encapsulated message. The terminal application must implement redundancy, fault tolerance and guarantee of message delivery from each store terminal to the terminal application.

The terminal application must ensure that stored messages are retrieved in the fastest and safest way possible. Each store must be authenticated before its terminal daily transaction record is processed.

The POS terminal application shall ensure that each update to all Enterprise Information Systems participating in the daily transaction modification is successful; otherwise the transactional record shall be rolled back and a failure notification will be sent to the store that owns the terminal.
 This application shall provide direct data and application integration with the existing Enterprise Information Systems; impact to the existing legacy applications shall be kept to a minimum.

Figure 3.0.4 provides the activity diagram for this process.

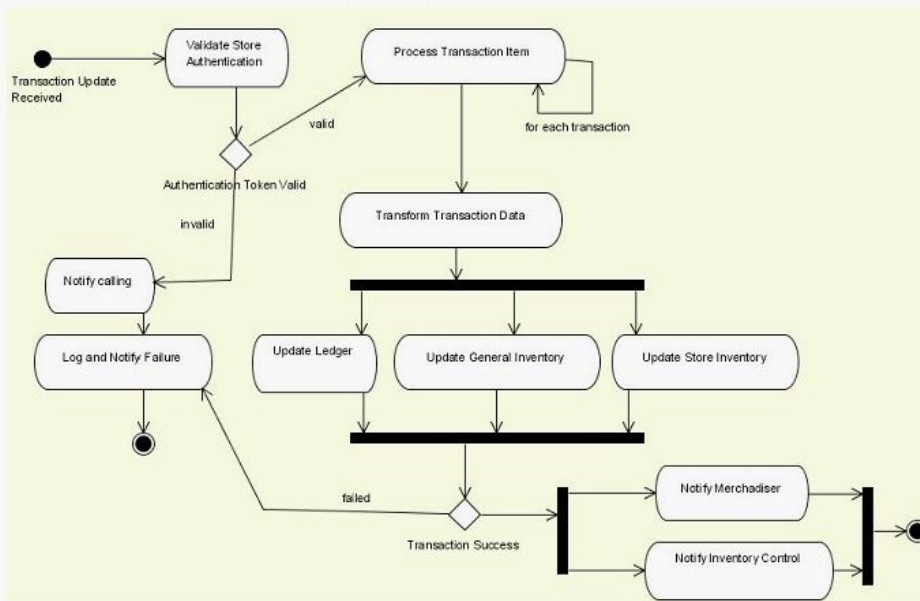

Figure 3.0.4 Daily Transaction Upload

4.0 Network Model

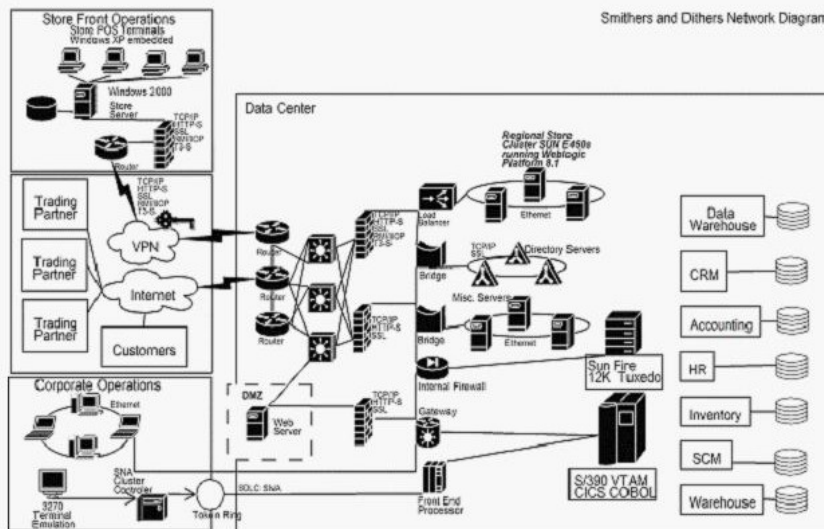

Figure 4.0.1 Network Diagram

- A. Publish WebLogic Portal JMX MBean APIs to each business partner
- B. Design one or more WebLogic Server Messaging Bridges with J2CA adapters
- C. Configure a Trading Partner Management repository with WebLogic Integration
- D. Use WebLogic Workshop to wrap coarse-grained business functionality as Web Services
- E. Use the Liquid Data View Builder to design and build custom queries for integrated data access

Answer: C

- 2. Scenario: The Notify Merchadiser and Notify Inventory Control steps defined in FR004's activity

diagram should be invoked in parallel. Which of the following is NOT a valid architectural approach based on this use case requirement?

- A. Send notification messages to two separate JMS Queues monitored by both consumers
- B. Send one notification message to a single JMS Topic which maintains a separate subscription from both consumers
- C. Send notification messages directly to two Message-driven EJB callback objects provided by both consumers
- D. Send one notification message to a single JMS Topic which maintains a separate subscription from both consumers within a single XA transaction
- E. Send two notification messages to a single JMS Queue using a JMS message selector by each consumer

Answer: C

3. Scenario: The activity diagram for FR004 details dependencies on other applications whose requirements are defined in separate use cases. A primary requirement for the new POS application is that it must accommodate future architectures and currently-unknown internal and external clients. Given the path defined by FR004's activity diagram and the non-functional requirement, answer the following question. The activity diagram and use case specify that if an update to an EIS fails, the process must roll back the current transaction. Assuming that each update is asynchronously invoked, what is the best way to handle transaction rollback within this process?

- A. Use a standard XA transaction employing two-phase commit
- B. Define an explicit transaction boundary within the process definition
- C. Use the transaction propagation facilities of J2CA and execute each update from the XA transaction context of the process
- D. Use a compensating transaction after each callback from the EIS' update operation that manually restores the affected data
- E. Implement a custom exception path within the process that invokes the rollback method of the related global distributed transaction

Answer: E

4. WSRP is an attractive option for web development because it decouples the deployment and delivery of applications. WebLogic Platform allows for the creation of WSRP-enabled portlets EXCEPT for which portlet type?

- A. Struts
- B. Pageflow
- C. HTTP Web Service

- D. JSR168 Java Portlet
- E. JSP Portlets using a JPF

Answer: C

5. Smithers and Dithers' architecture must accommodate multiple Web requests, which may demand various preprocessing and postprocessing activities. Which Design Pattern best describes a solution that meets this requirement?

- A. Flyweight
- B. View Helper
- C. Front Controller
- D. Composite View
- E. Dispatcher View

Answer: C

6. You have determined that your Web Applications will be deployed to a WebLogic cluster for high availability. In order to take advantage of HTTP session replication, which of the following is required?

- A. All session data must be serializable
- B. Replication Groups must be configured
- C. One member of the cluster must be used as the proxy server
- D. All members of the cluster must be located within the same subnet
- E. At least two cluster members must be running on separate machines

Answer: A

7. Scenario: Use Case FR004 gives the requirements for the daily transaction upload that every store POS terminal must complete. The associated activity diagram provides the path through this use case. You decided to implement this functionality as a separate Java Process Definition using WebLogic Integration. Use this information to answer the following question. Given the requirements of FR004 for guaranteed message delivery, which architectural approach provides the best solution for maximum performance throughput?

- A. Configure the store's JMS server to use persistent message delivery using a JDBC backing store.
- B. Configure the POS terminal's JMS server to use persistent message delivery using a JDBC backing store.
- C. Configure the POS terminal's JMS server to use persistent message delivery using a file store as the message's paging store.
- D. Configure the store's JMS server to use persistent message delivery using a file backing store. Use a common network mount point and a file directory on a RAID array.
- E. Configure the POS terminal's JMS server to use persistent message delivery using a file backing store.

Use a common network mount point and a file directory on a RAID array.

Answer: D

8. Smithers and Dithers will be using HP Openview for all SNMP management. Which of the following is NOT true concerning WebLogic Server's SNMP capabilities?

- A. The WebLogic SNMP agent supports both SNMPv1 and SNMPv2 protocols
- B. The WebLogic SNMP agent can only run on a domain's Administration Server
- C. Each MBean attribute in the MIB is an SNMP managed object with a unique object identifier
- D. The WebLogic SNMP agent can be configured to respond to simple GET and SET requests
- E. The WebLogic SNMP agent can act as a proxy to other SNMP agents on the same machine

Answer: D

9. Scenario: The diagram represents the interactions of the Inventory system with external entities during the processing of a purchase order. The activity is completely described in Activity Diagram. In this business process, the PO is presented to a merchandiser; a warehouse confirms storage requirements; and the information is used to update the accounting system, asynchronously. Which type of invocation model is best suited to implement Use Case FR002?

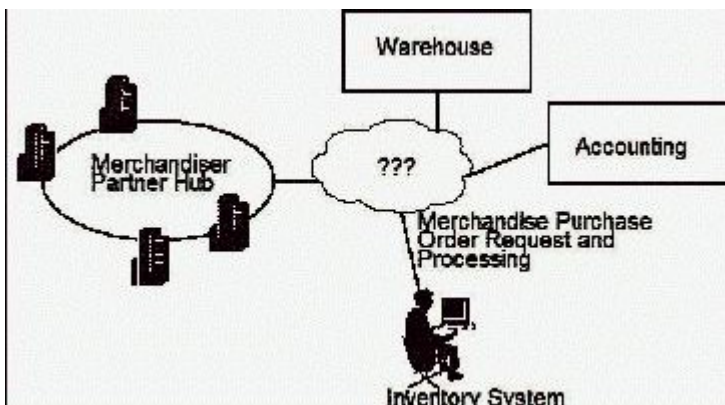

- A. Creating a command object that delegates passing parameterized messages, asynchronously.
- B. A synchronous invocation on every module required to implement the functionality defined by the Use Case
- C. An asynchronous invocation of each notification sub-system, which delivers the appropriate message to the appropriate message destination.
- D. Using a separate delegate object, which creates a thread pool using separate threads to invoke each operation concurrently and perform thread monitoring and management
- E. Scope each synchronous invocation within a single XA transaction.

Answer: C

10. Within a Service-Oriented Architecture, which of the following is NOT a Connectivity Layer component?

- A. Portlet

- B. EJB Control
- C. Java control
- D. J2CA Adapter
- E. Application View

Answer: A